

| | | |
|---|-------------------|----------|
| T-4 | | |
| File: gijisat-rev2.sch | | |
| Sheet: / | | |
| Title: GJI-SAT PCB | | |
| Size: A4 | Date: 20 nov 2013 | Rev: 2.0 |
| KiCad E.D.A. eschema (2013-07-07 BZR 4022)-stable | | Id: 1/4 |

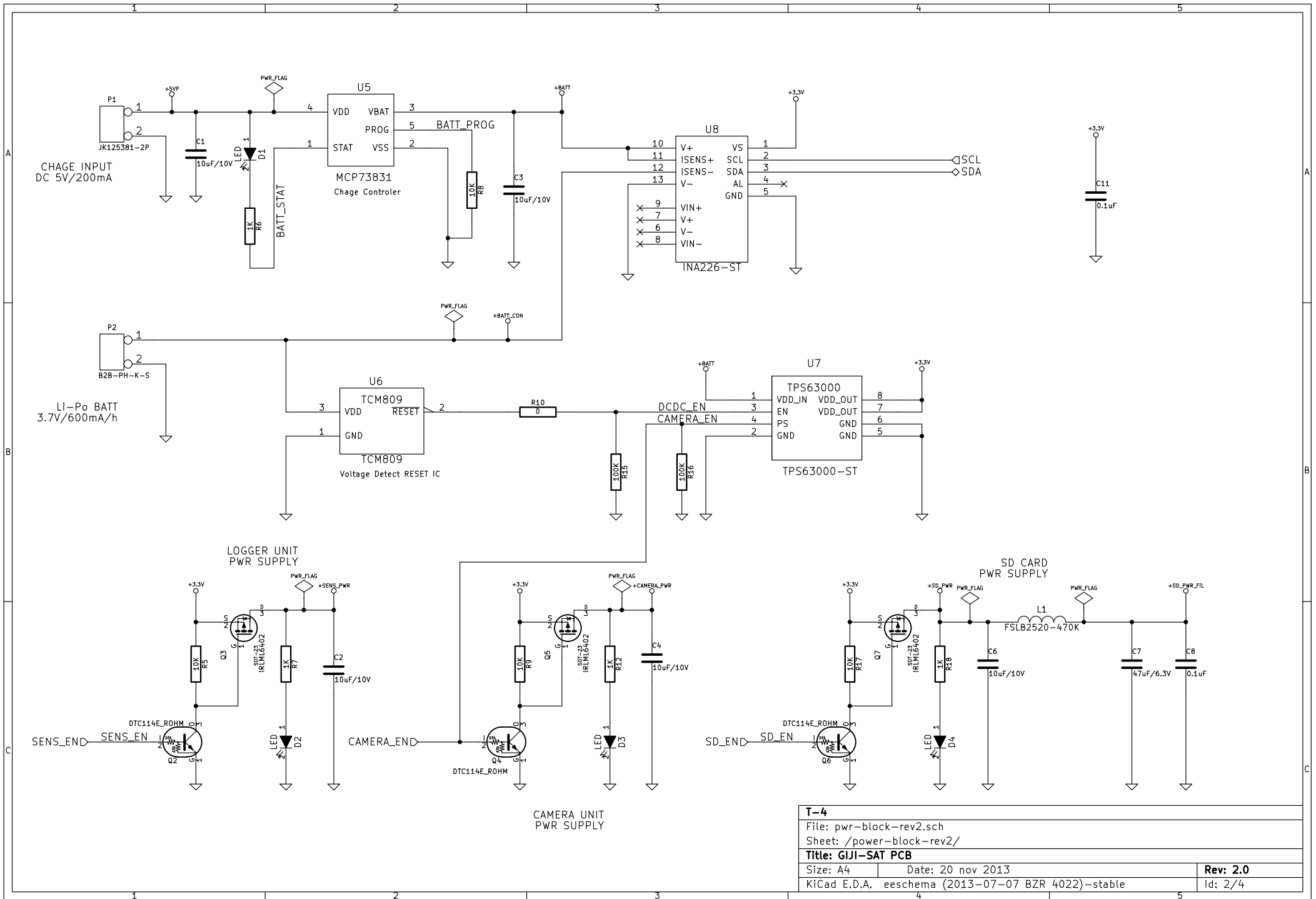

| | | |
|---|-------------------|-----------------|
| T-4 | | |
| File: pwr-block-rev2.sch | | |
| Sheet: /power-block-rev2/ | | |
| Title: GIJI-SAT PCB | | |
| Size: A4 | Date: 20 nov 2013 | Rev: 2.0 |
| KiCad E.D.A. eschema (2013-07-07 BZR 4022)-stable | | Id: 2/4 |

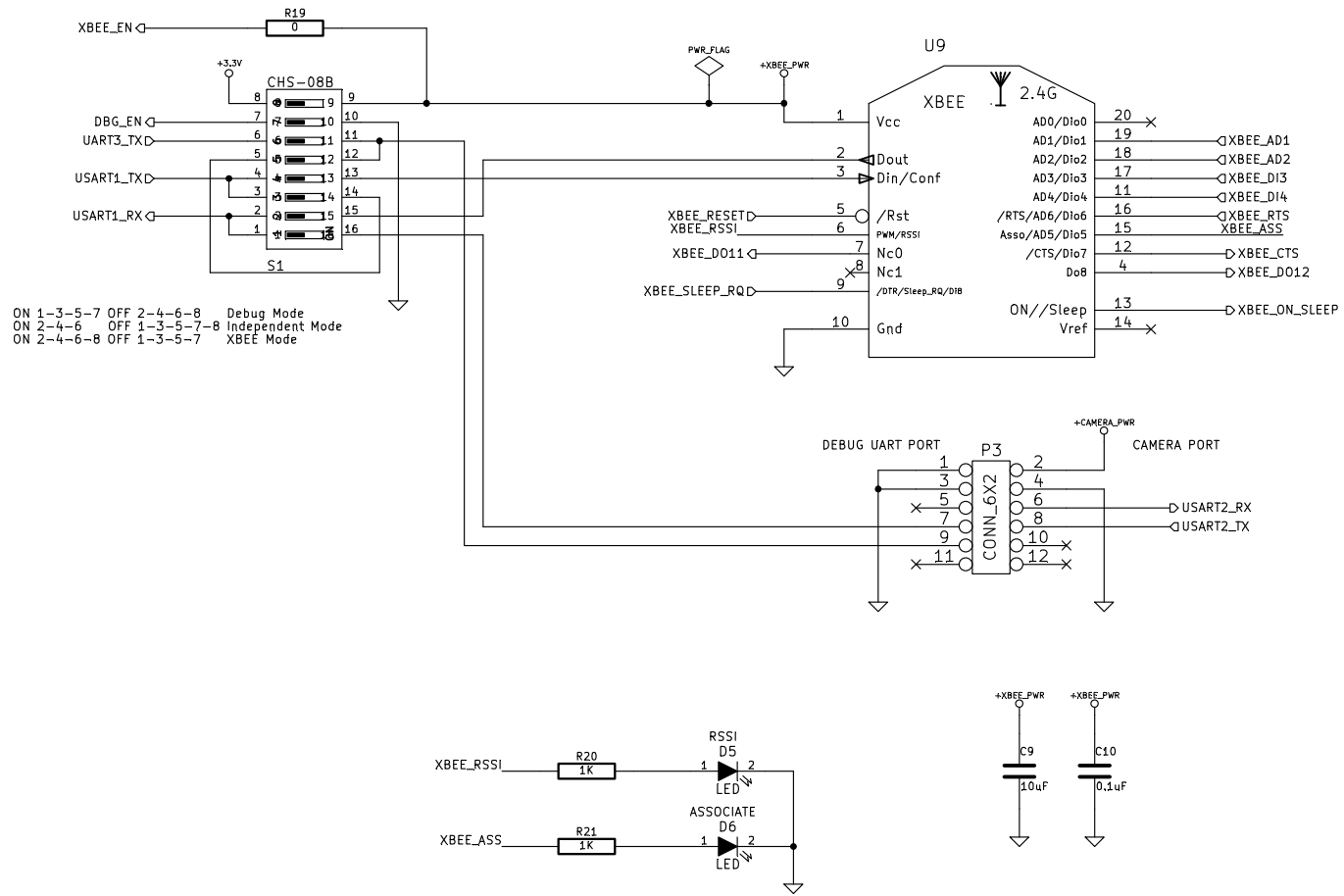

| | | |
|---|-------------------|-----------------|
| T-4 | | |
| File: xbee-block.sch | | |
| Sheet: /xbee-block/ | | |
| Title: GIJI-SAT PCB | | |
| Size: A4 | Date: 20 nov 2013 | Rev: 1.0 |
| KiCad E.D.A. eschema (2013-07-07 BZR 4022)-stable | | Id: 3/4 |

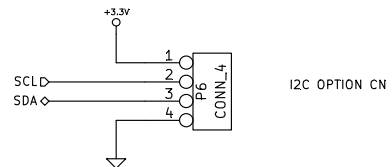
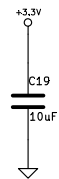
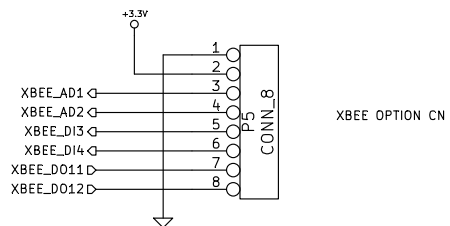
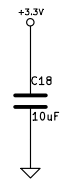
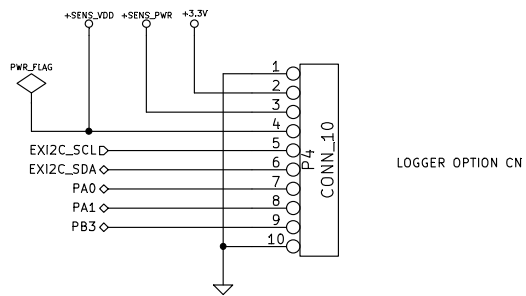

| | | |
|--|-------------------|-----------------|
| T-4 | | |
| File: cn-block-rev2.sch | | |
| Sheet: /cn-block-rev2/ | | |
| Title: GIJI-SAT PCB | | |
| Size: A4 | Date: 20 nov 2013 | Rev: 2.0 |
| KiCad E.D.A. eeschema (2013-07-07 BZR 4022)-stable | | Id: 4/4 |